



GIRARD PRODUCTS. LLC.

## Technical Manual

### Model: GSWH-2

**Features:**

- Demand Tankless Water Heater
- LP Gas / Induced Draft
- Constant Outlet Temperature
- Linear Gas Control Valve
- Electronic Gas Modulation
- Microprocessor Controls

- **Operation**
- **Functional Tests**
- **Troubleshooting**
- **Service and Maintenance**

Service must be performed by a certified installer, service agency or gas supplier.

This water heater is certified for installation in Recreation Vehicles (RV's) and is not for use in Marine or Space Heating Applications.

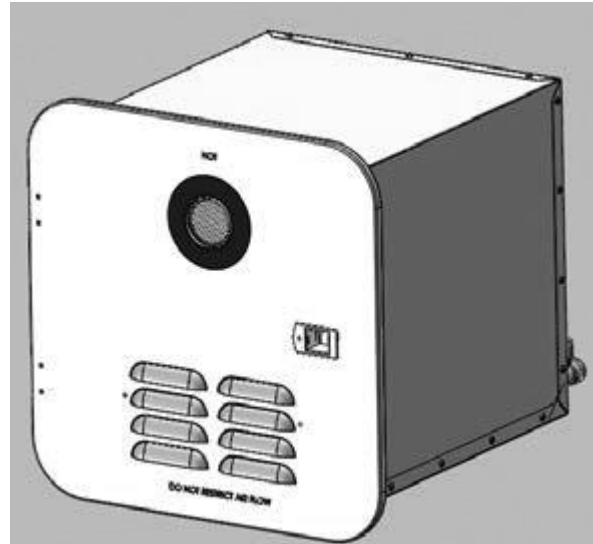

For service and spare parts:

- **Girard Products LLC**  
**2515 Lombardy Dr.**  
**Goshen, IN 46526**  
**866-559-1221**

Girard Products LLC, 1361 Calle Avanzado, San Clemente CA 92673 USA

Patent Pending

## TANKLESS WATER HEATER - Model GSWH-2



### CONSUMER SAFETY WARNING!

- Use with Universal LPG only.
- Shut off all gas appliances and pilot lights when refueling.
- Turn gas OFF at the LP tank when vehicle is in motion. This disables all gas appliances and pilot lights. Gas appliances must never be operated while vehicle is in motion.
- LP tanks must be filled by a qualified gas supplier only.
- Should overheating occur, turn gas OFF at the LP tank and turn the operating switch to the OFF position.

### In a conventional installation the Girard Tankless Water Heater is dependent on and connected to:

1. **Input Water flow:** The RV's cold water system deriving its water input from a pressurized (45 PSI or greater) source such as a shore connection or an RV water pump connected to the RV's fresh water storage tank.
  - A steady water flow (no pulsating) will ensure a consistent temperature and performance.
  - Water Pressure regulators are commonly recommended but they often decrease water flow to unacceptable levels.
  - Water filters are highly recommended to keep sediment out of the plumbing system but the need to be maintained or they can restrict water flow.
  - Winterization by-pass kits are not recommended in a tankless water heater systems. They can cause a number of plumbing issues that will affect the operation of the water heater.
  - City water connections at RV parks can have low or varying water pressure. If this condition occurs and cannot be resolved, then we recommend filling the fresh water tank and using the onboard water pump.
2. **Output Water flow:** The RV's hot water system (i.e. faucets and shower).
  - Purge all air from the plumbing system using both the water pump and city water source. Air in the plumbing can cause intermittent heating operation errors.
  - Pressure is important but actually water flow is critical to the operation of a tankless water heater. The longer the water stays in the water heater the hotter it will become. The water flow is dependent on the plumbing and fixtures of the RV. The length of plumbing, the amount of elbows and the restrictions in the faucets and shower heads. Experience has shown us that the average RV water flow is between 1 and 1.4 Gallons per Minute. This water flow will give you the optimal operation of the water heater.
  - The water heater is equipped with a water control valve to help maintain this optimal water flow especially in winter conditions where input water temperatures below 45 degrees. The water heater is shipped with the water control in the maximum flow setting.



3. **LP Gas System:** The RV's LP Gas system capable of supplying its rated 42,000 BTU requirement.

- The Girard Products model GSWH-2 introduces a new generation of smart tankless water heater designed specifically for Recreation Vehicles (RV). Its configuration and size are consistent with the tank based RV water heaters currently in use and is designed for OEM's and after-market use by the RV Industry.
- LP system issues can occur that can adversely affect the operation of the water heater so it is important that the LP system is maintained.
- Gas pressure drop test requirements vary from state to state but the RVIA regulation states that gas system should maintain 8" WC for 3 minutes.
- LP tank and bottles must be purged correctly when filled, especially upon the first fill, to ensure that all of the air has been eliminated from the LP cylinder. If this is not performed gas appliances will not work or not perform as required. When the cylinders are not filled properly we often see insufficient temperature rises from the water heater.
- Gas pressure of 11" WC is the recommended minimum pressure for the proper operation of the water heater. This test must be performed with a minimum of half the gas appliances operating.
- Cold weather conditions will affect the output BTU's of the LP cylinder. The smaller the cylinder the less output can occur.
- Debris and a build-up of oil in the LP plumbing can restrict gas flow to the appliances.

4. **12VDC Power:** The RV's 12VDC electrical power system. Proper 12VDC and ground is required for proper operation of the water heater. Low voltage or bad voltage will cause non-operation or failure of the water heater.

- The water heater will not function when input voltage drops below 10VDC. When this happens a red LED will illuminate on the water heater control board.
- Over the years we have seen a drastic improvement with power converters and inverters. The poor power output of an older linear style converter can cause issues with modern electronics. If using this water heater with older converters we recommend wiring through the battery or on the filtered side of the converter so the battery can act like a capacitor and filter the voltage.

## Understanding How the Girard Tankless Water System Works

**The Water Heater's microprocessor based controller (Control Board) receives from electronic sensors the data it needs to decide each step of the Model GSWH-2 operation.**

1. The User Control Panel (UCP) displays each phase of the Water Heater's operation and receives from the user the operational parameters desired:
  - ON/OFF to activate
  - Desired outlet temperature
2. Verify that all components are in working order and that it is safe to start the unit upon sensing the minimum amount of water flow required (.70 GPM +/- 10%)
3. The water heater will continue operation as long as:
  - The water flow is above the minimum required
  - The presence of flame is verified
  - No unsafe condition develops
4. The UCP will provide the user with a visual indication of the operating conditions illuminating the appropriate icon and displaying the current outlet temperature:
  - Fan icon on: Blower operating
  - Flame icon on: Burner is lit and flamed is detected
  - Shower Head on: Water is flowing

5. The button marked “C/F” determines if the temperature is displayed in °F or °C degrees
6. Whenever the “UP” or “Down” are pressed the display shows the set temperature.
7. If an unsafe condition is encountered and the unit shuts off, the display will show an Error Code corresponding to the actual condition that caused the unsafe condition.



The Model GSWH-2 can be operated from the User Control Panel (UCP) which includes the Power ON/OFF switch.

**The model GSWH-2 can be operated in two different ways:**

1. Operate like a Tank Water Heater. The user turns on the hot water and adds cold water to achieve the desired Hot water temperature.
2. Select the desired temperature by adjusting temperature setting up (^) or down (v). The UCP settings are from 95° (C) to 124° (C). The unit will maintain the set temperature.

Note – The recommended and Factory setting is 115° (F).

**For normal operation:**

1. Turn on the power. The panel will light and will display the current temperature at the inlet of the unit.
2. Press a temperature selection arrow (up or down) to see the current set temperature.
3. Adjust the set temperature to your preference.
4. Turn on the faucet.



**WARNING!**

It is dangerous to operate a Tankless Water Heater unattended. This may occur accidentally if a sufficient leak develops in the water system or if a faucet is left open. For this reason, The GSWH-2 will automatically turn off after operating for 20 minutes and displays Error “En” on the Display.

# Troubleshooting & Repair Guide

## Sequence of Operation

**a. Tools required:**

- |   |  |
|---|--|
| 1. Multi-meter                            | 4. Thermocouple readout or Thermometer |
| 2. Gas pressure manometer                 | 5. Wrenches (23MM, 19MM, 15MM)         |
| 3. Screwdrivers (Slot and Phillips heads) | 6. Pliers (Regular and Needle Nose)    |

**b. Installation verification:**

Open the door and verify that:

1. There is no obstruction to the air flow within the housing (Objects, dirt or other)
2. The Exhaust tube is free and clear of any obstruction (Leafs, insect nests, other)
3. Verify that the water inlet valve is wide open
4. Remove the Fuse located below the ON/OFF switch and verify that it is not blown.
5. Open lid of Control Box pulling on the left edge
6. Verify that the board is clean and shows no signs of burns or overheating around any component
7. Verify that all connections are in place and solid (See Figure 4 and Figure 5 below)
8. Turn ON power switch
9. Verify that the indicator light comes ON.
10. Verify that the unit is connected to 12VDC power supply using the Voltmeter (See section d.)
11. Verify that there is gas available (Tank not empty and lines full).

**When the Installation verification is completed open a faucet to operate the unit.**

**If any Malfunction occurs during operation, refer to the following illustrations to gain access to all major components of the unit and proceed to the troubleshooting procedures (see below in this manual). Unit cannot be operated without firewall in place. Make sure to determine a probable cause before gaining access to the major components.**

The table below summarizes the main performance specifications of the Model GSWH-2	
BTU/HR	42,000 BTU
Fuel	Propane (LP Gas)
Inlet Pressure	11" WCI Min to 14" WCI Max
Manifold Pressure	1.5" – 7.8" WCI
Power Input	12VDC < 3 amp
Water Operating Pressure	125 PSI Max
Dimensions	Width: 12.5" Height: 12.5" Depth 15.5"
Shipping Weight	22 lbs.
ECO	Max Temperature 140° (F)

# Static Operation – No Water Flow

## Input 12VDC Power:

Red wire positive and black wire ground to back of the water heater

Confirm that you have a good power source with filtered voltage. Older linear type converters can cause issues with the operation of this more advanced board.

12VDC Ground Black wire run direct to board through power connector

## Power Switch and Fuse:



12VDC Red wire positive to the power switch.

12VDC Red wire from the switch to the fuse.

12VDC Red wire from the fuse to the power connector.

12VDC Red Wire from the power connector to the board.

Black Negative  
Red Positive



Power between the red and the black wires eliminates the fuse, switch and incoming power supply. Ensure the ground is good.

## Removal and replacement of fuse and switch:

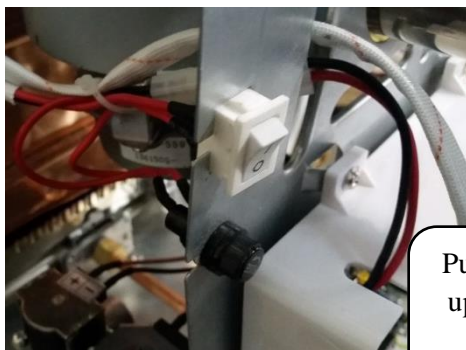

Push down on top tab and  
up on the bottom tab and  
pull forward

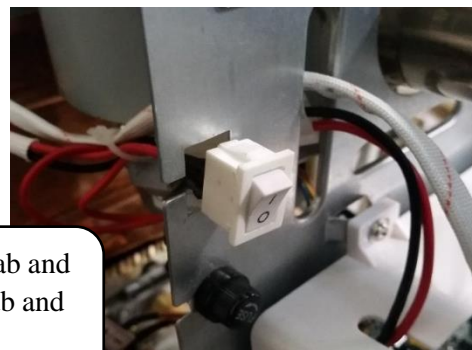

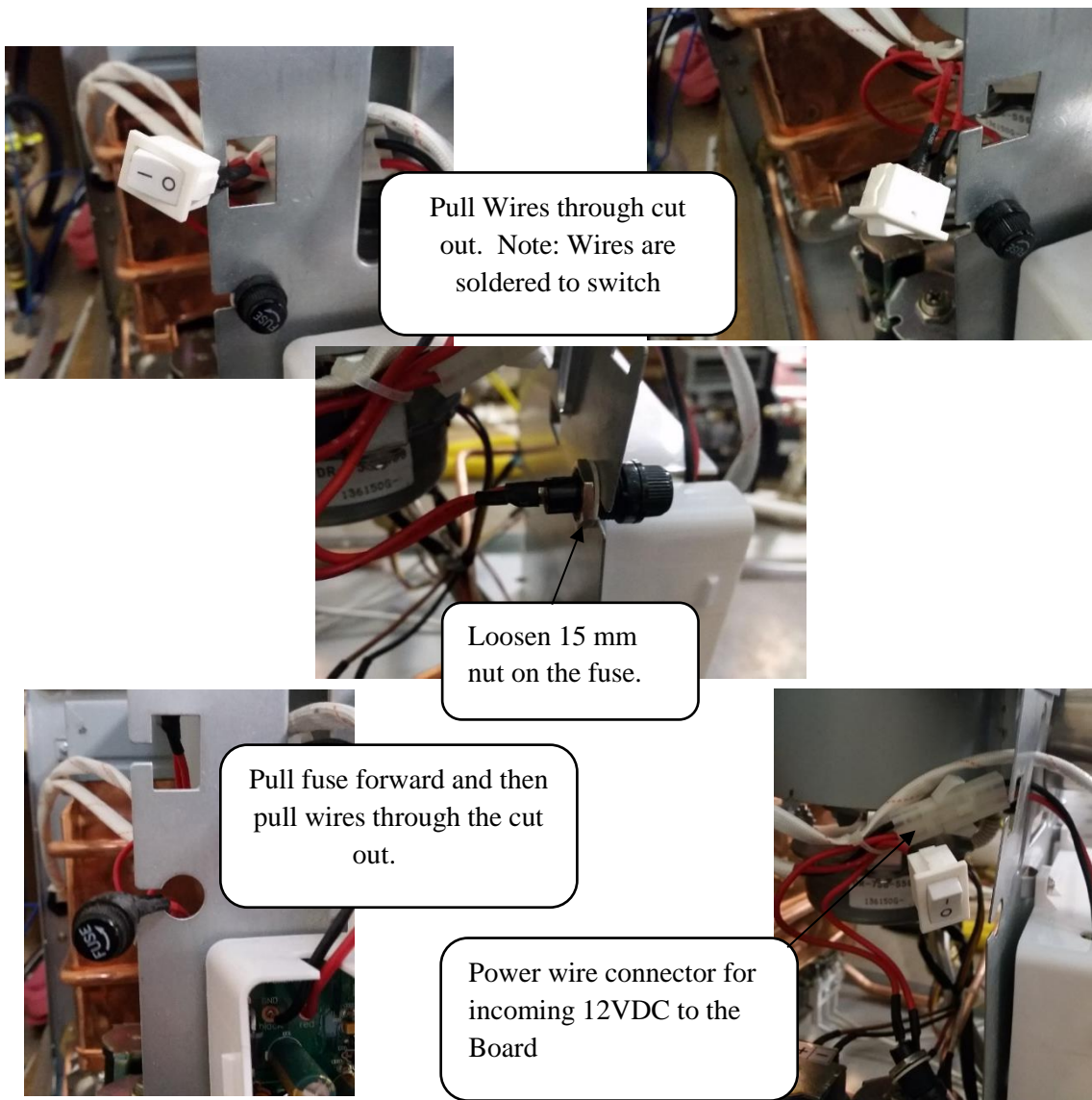

## **Operational Indicator LED's**

These LED's indicate proper voltage and operation of the water heater. Voltage below 10VDC will cause the red light to illuminate and the board will not engage operation of the water heater.

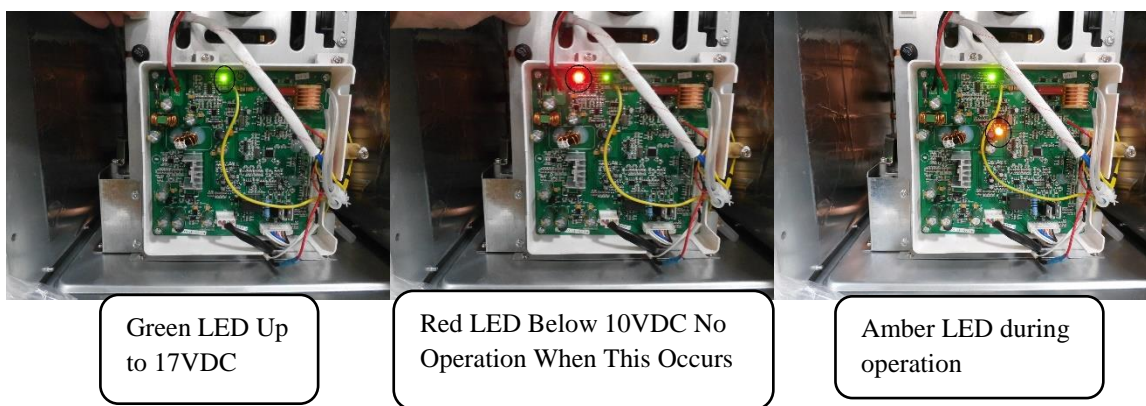

## User control panel



- Recommended Setting 115 degrees.
- Icons showing temperature setting, Output Temperature, Fan, Flame and Water Flow. These are important to troubleshooting.
- Confirm that you can change the temperature setting on the UCP.
- Wire connections.
- Damage to the control board may occur if the blue wires between the Control board and the UCP are connected to ground or 12VDC or crossed.

## No Operation of the UCP

1. Confirm operation of the UCP. Turn on switch, back light operation, change the temperature setting.
2. Confirm good power and ground to Control board and the green light is on. Check the wire connection at the XK terminal.
3. Check voltage between the 2 wires at the connection of the UCP. You should find a fluctuating voltage of 9 to 11VDC.
4. Check voltage between the 2 blue wires at the XK Connector. You should find a fluctuating voltage of 9 to 11VDC.
5. If there is no power to the UCP but it is present at the board then there is a wiring issue between the UCP and the control board.
6. If you have no power at the UCP and no power at the control board then the control board is bad. But there may still be a wiring issues that may have caused the board to fail. Eliminate before replacing the control board.
7. If the wires are crossed then the board next to the XK Connector will get hot. Discoloration will occur on the board and the control board may fail.
8. If the wiring between the UCP and the control board is shorted to ground or 12VDC then discoloration may occur and you will get erroneous readings at the UCP and the control board may fail.

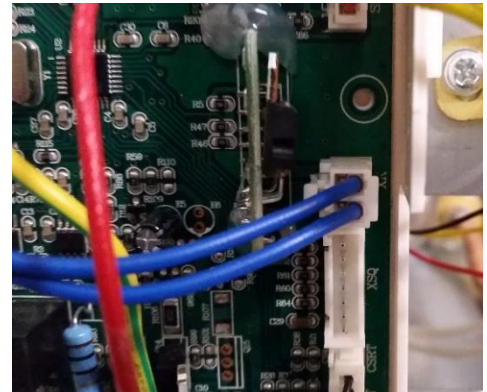



# Hot water flow on - Pre-Trial for Ignition

## Water Flow Sensor:

As the water flow increases the board will increase the BTU's to compensate for the lower temperature rise. As the water flow decreases the board will decrease the BTU's to compensate for the higher temperature rise.

The water flow sensor or water flow meter gives the actual water flow measurement to the control board. As water flows through the flow meter. The fins in the flow meter spin the water through the flow meter which turn the magnetic impeller. The board sends 5vdc to the flow meter. The Reed switch on the side of the flow meter turns on and off quickly as the magnetic impeller turns past it. This changes the "frequency" of the power coming back to the board. The board actually reads the "frequency" determining how fast the impellers are turning. The flow meter cannot be tested with a resistance check.

The simplest way to determine that the board has confirmed that the water flow meter has engaged is by examining UCP. If the water flow icon (a shower head symbol) is active on the User Control Panel when the hot water faucet is turned on then the flow meter can be eliminated.

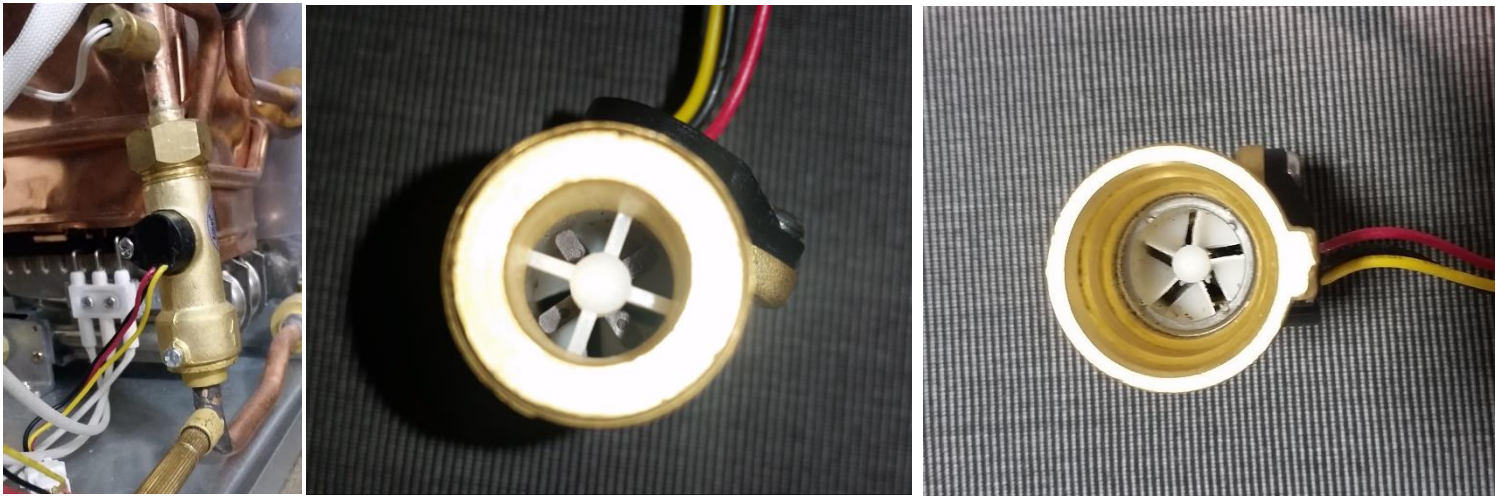

The control board starts the operation of the water heater when the water flow exceeds .80 GPM (+/- 10%).

Confirm the actual water flow by timing how long it takes to fill a gallon container. Divide 60 seconds by the seconds measured to come up with the GPM.

If the water flow is too low then you will need to inspect the **Water Control Valve** adjustment on the water heater. Ensure that it is opened all of the way up.

Other causes of reduced water flow are plumbing restrictions, pressure regulators, water filters and insufficient shore or pump water pressure.

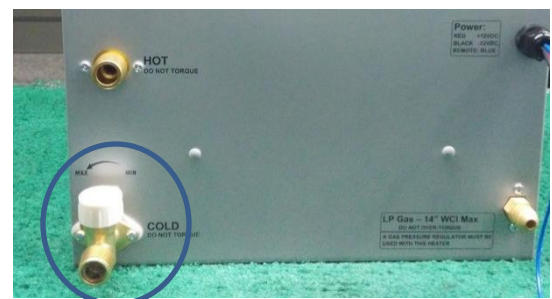

Mixing of hot and cold water will restrict the water flow through the water heater. When mixing hot and cold water at the faucet you will start to diminish the flow through the water heater. When the flow is low enough the board will no longer sense that there is enough flow of water and the board will turn off the operation of the water heater.

Other plumbing issues can cause a mixing of hot and cold water. Winterization bypass kits may be set incorrectly causing a mixing hot and cold water. Also, in many cases, if you turn on the outside shower valves and turn off the shower head you will mix hot and cold water through the system.

Another plumbing issue is the polarity of the water flow through the water heater. If the plumbing lines are reversed then the impeller in the flow sensor will not activate. The fins in the flow meter spin the water which spins the impellers. If water is going the wrong way through the water heater the impellers will not spin and the flow meter will not operate.

We have seen grease like deposits on the impellers of the flow meter causing the flow meter to read slower the actual water flow is through the water heater. If the water heater will not turn on above .80 GPM and plumbing issues are eliminated then the flow meter will need to be changed.

## Voltage test

This test will confirm if the impellor is turning but will not tell you the actual water flow. If you do not see a voltage drop to approximately two volts then 1) the impellor is jammed 2) the water is not flowing through the water heater 3) the water is flowing the wrong way through the water heater 4) the Reed switch of the flow meter has malfunctioned.



Water flow off:

5 VDC between the black and the red.

5 VDC between the black and the Yellow.

Water Flow On:

5 VDC between the black and the red.

2.6 VDC between the black and the yellow.

Note that if the flow meter fails it will not generate a fault code. The water heater will simply not turn on.

## Removal and Replacement of the Flow Meter

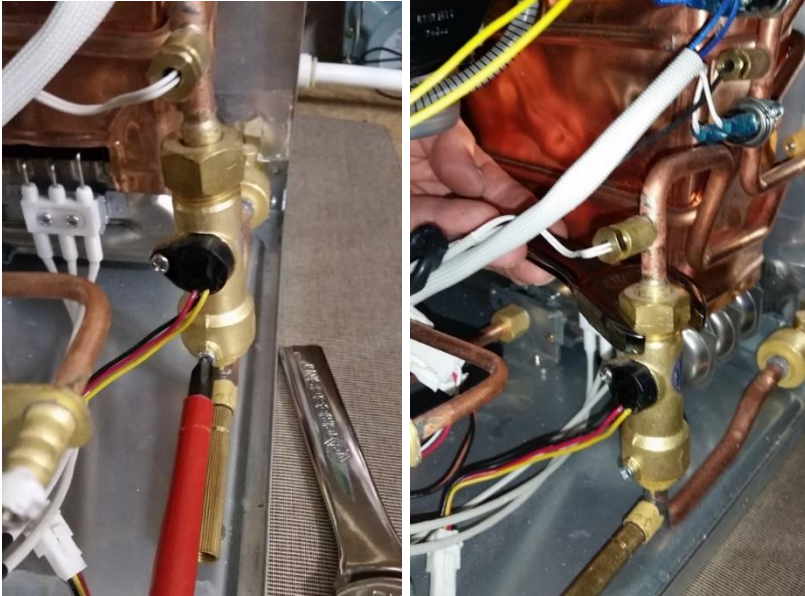

1. Remove the set screw on the front of the flow meter.
2. Loosen the compression fitting on the top of the flow meter using a 5/16" or a 23mm wrench.
3. Twist the flow meter plumbing and pull the flow meter upward. Ensure the top O ring is not damaged or discarded.



4. After removing the flow meter check the integrity of the bottom O ring.
5. When reinstalling the flow meter ensure it is fully ceded to avoid water leaks. Reinstall the 23mm compression fitting. Do not overtighten.
6. Reinstall set screw.
7. Check for leaks.



## ECO

**AKA: Emergency Cut Off, Energy Cut Off, and High Temperature Limit Switch. The temperature setting that the ECO turns off at is 140 degrees.**

**Although Purging of air out of the plumbing is less crucial with this model it is still important to prevent intermittent overheating or erroneous heating issues.**

Once the board senses water flow then the board will read the ECO to ensure it is not open.

The wire connections on the ECO are clip type spade connections. Pull back the insulation over the spade connection and push the clip down and pull simultaneously.



If the ECO is tested open by the control board when the hot water faucet is turned on then the control panel will show the water flow symbol and an E3 fault. The fan will not turn on.

If the water temperature reaches approximately 140 degrees during operation then the E3 code will show on the control panel and then the burner will turn off immediately and the fan will turn off after approximately 15 seconds. The E3 fault code will stay on the control panel until the hot water faucet is turned off and turned back on again or the board is reset.

Two Fault codes are generated if overheating conditions occur.

**E3: ECO open before ignition or during normal operation.**

This occurs if the ECO thermostat opens. Under normal circumstances this is due to the Temperature of the water at the Outlet exceeds 140 F. The cause must be identified and removed before restarting the unit.

**E6: Over Temperature.**

Outlet Water Temperature has exceeded 140°F (60°C) for 3 sec.

The main cause of overheating in this water heater is purging all of the air out of the plumbing and high temperature cold water coming into the water heater. Southern states in the summer time can get extremely warm water right out of the ground. When these conditions occur ensure that your water flow is proper.

## Input and Output Thermistors

The water heater is equipped with an input or cold water thermistor and an output or hot water thermistor. These thermistors will give the control board the actual temperature of the incoming cold water and the outgoing hot water temperatures. The board will adjust the BTU's to the gas valve to meet the requirements of the set temperature of the UCP.

**The operating temperature shown at the UCP is the temperature of the output (Hot) thermistor.**

If the output thermistor is open when the board senses that the flow sensor is on then an E0 fault code will be given.

**E0: Water Outlet Temperature Probe failure.**

An open circuit or short circuit condition is detected: This could be due to an internal failure in the Temperature Probe or to a faulty connection (Wires)

If an E0 or E4 fault occur verify with a voltmeter that the resistance of the thermistor is not an open circuit or a short.

Verify wire connections are good.

If the temperature of the water displayed at the UCP is nowhere near the temperature of the water coming out of the water heater you may have a thermistor out of calibration. Check the temperature on the copper pipe where the output thermistor is located with a laser thermometer to confirm the temperature.

This issue can also be a result of a mixing of hot and cold water in the plumbing system. The standard plumbing issues that cause this problem are mixing through a winterization by pass kit or if the valves on the outside shower are turned on and the outside shower head is turned off.

High temperature incoming water will force the water heater to its lowest BTU's. When this occurs mixing of cold water in at the faucet will decrease the temperature of the water of the faucet but it will decrease the water flow through the water heater causing the temperature at the water heater to rise. This higher temperature will show on the UCP.

If the input thermistor is open when the board senses that the flow sensor is on then an E4 fault code will be given

#### **E4: Water Inlet Temperature Probe failure.**

An open circuit or short circuit condition is detected: This could be due to an internal failure in the Temperature Probe or to a faulty connection (Wires)

### **Thermistor Removal and replacement**

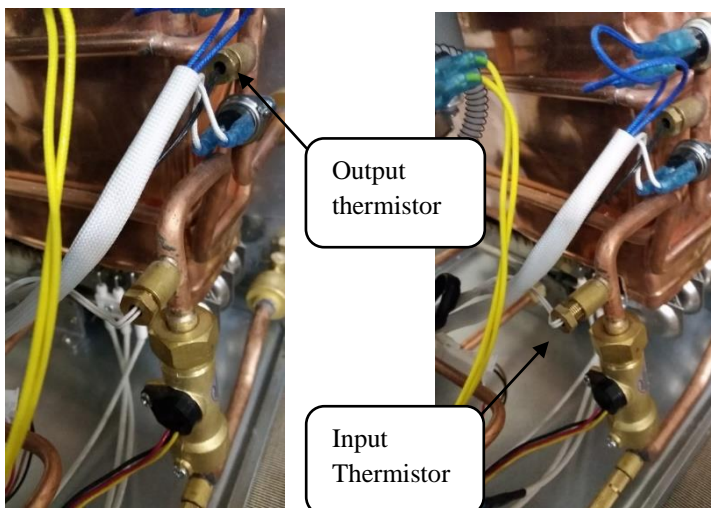

Turn off the water supply.

Identify input and output thermistors. Remove compression nut using an 11mm crow foot wrench.



The thermistor is sealed into the water systems with an O Ring. Reach in with needle-nose pliers and firmly pull thermistor out of the fitting. Do not damage or discard the O ring.

Remove the wire from the control board.

Reinstall in reverse order.

Check for Water Leaks.

## Blower Motor Operation

This water heater is equipped with a 4 wire variable speed brushless motor. The motor operates with a 24VDC pulse width modulation system. Which means there is Voltage at all 4 wires on the CN1 plug with or without the motor running.



When the hot water faucet is turned on the water flow symbol (showerhead) will turn on at the UCP. Then the control board checks the thermal sensors and thermistors for proper operation. Then the control board turns on the motor. The control board creates a 24VDC pulse width modulation power to the motor. Although voltage can be measure at the connector it is not possible to determine the proper voltage with a Volt Meter.

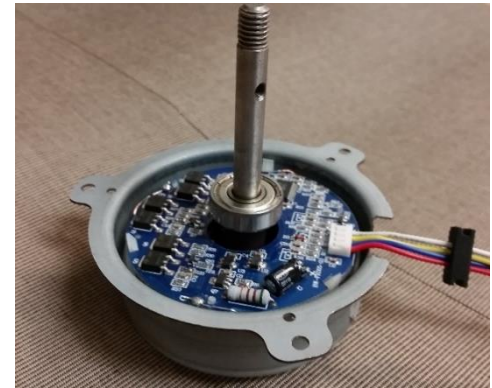

If an E5 fault code shows on the UCP:

1. Check the CN1 connection at the control board.
2. Check for debris in the blower assembly.
3. Ensure that you have good power and ground. Older linear converters can make it difficult for the board to put out the proper power to the motor.
4. Then the motor is bad and the motor or the water heater will need to be replaced.

### **E5: Blower motor failure.**

No motor signal was detected before ignition or during normal operation. This could be also caused by a wiring fault in the motor connections.

If the motor does not turn on and there is no E5:

1. Check the CN1 wire connection at the control board.
2. Check the UCP for the water flow icon.
3. Check for debris in the blower assembly.
4. If the connection is good and the water flow icon is on and the blower motor is not operating, then replace the control board.

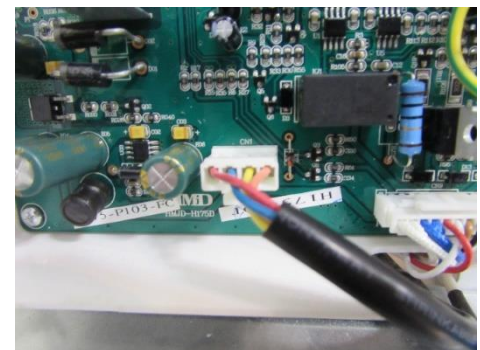

## Pressure Switch

The pressure switch is the air proving device on the water heater. It is vital that the fan is operating before the board goes into ignition mode.

The pressure switch contacts close as the air from the fan passes over the Petit Tube inside the blower housing. This creates a suction on the hose that connects the fan housing to the pressure switch. This will pull the contacts of the pressure switch closed.

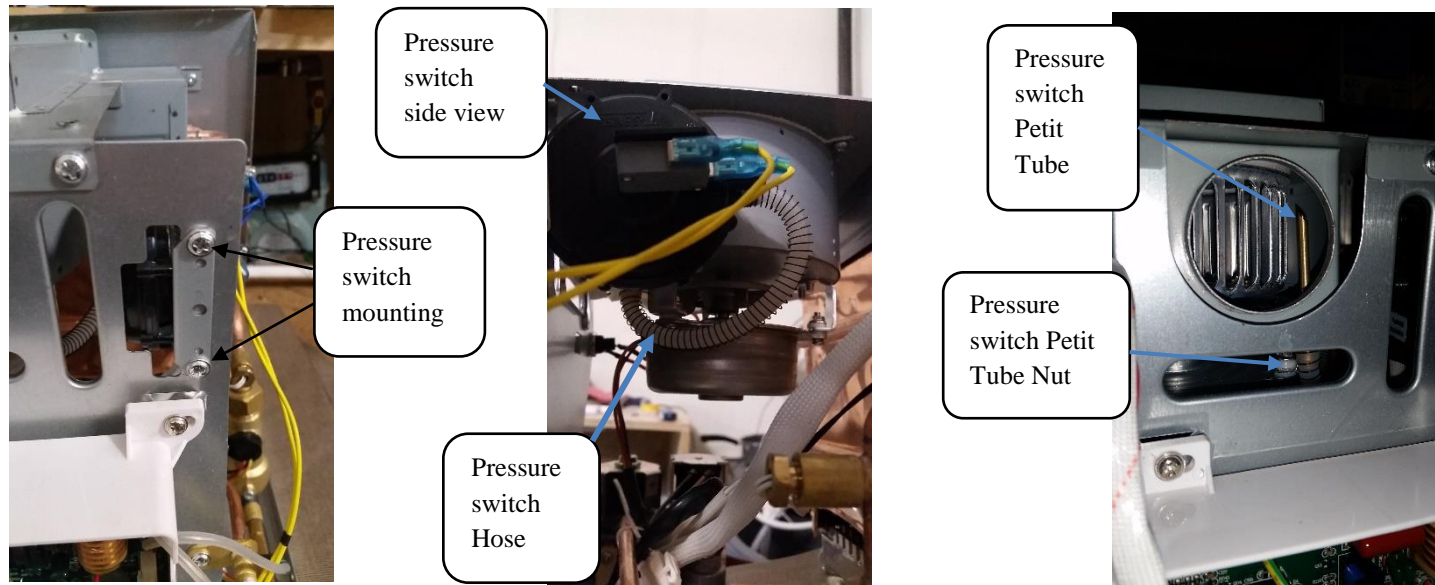

### **E8: Air pressure switch:**

Air pressure switch not detected for 7 sec. before ignition or is cut-off for 2 sec. during normal operation. This failure may be caused by a faulty motor or a blockage in the air supply or in the exhaust system.

An E8 fault is read when the control board does not see the pressure switch close. Remove the mounting screws of the pressure switch to get better access to the components and eliminate the following before replacing the pressure switch.

1. Check for integrity and connections of the hose.
2. Check the wire connections on the board and the pressure switch.
3. Check the integrity of the Petit Tube in the blower housing. Ensure the mounting nut is not loose and the standpipe is not twisted out of position. The petit tube should be facing away from the blower wheel. (works with suction)
4. Check for debris in the open pipe of the pressure switch.
5. Once the above conditions have been eliminated remove the pressure switch completely. With the pressure switch removed you can apply suction to the port the hose is attached and confirm with a continuity test if the switch is not actuating.

# Trial for ignition

## Control Board

Once the board senses the water flow meter, ECO, Thermistor, Motor Operation and Pressure switch activation then the board will power the gas valve and send high voltage for the spark.

This is a two try board.

If there is no ignition then you will get an E1 fault code and you will need to perform a soft reset by turning the water flow off and then back on again.

## Proportional Gas valve

This is two gas valves in one. One side of the gas valve is the on/off solenoid. The other side is the linear valve which adjusts the amount of gas and gas pressure to the burner orifices.

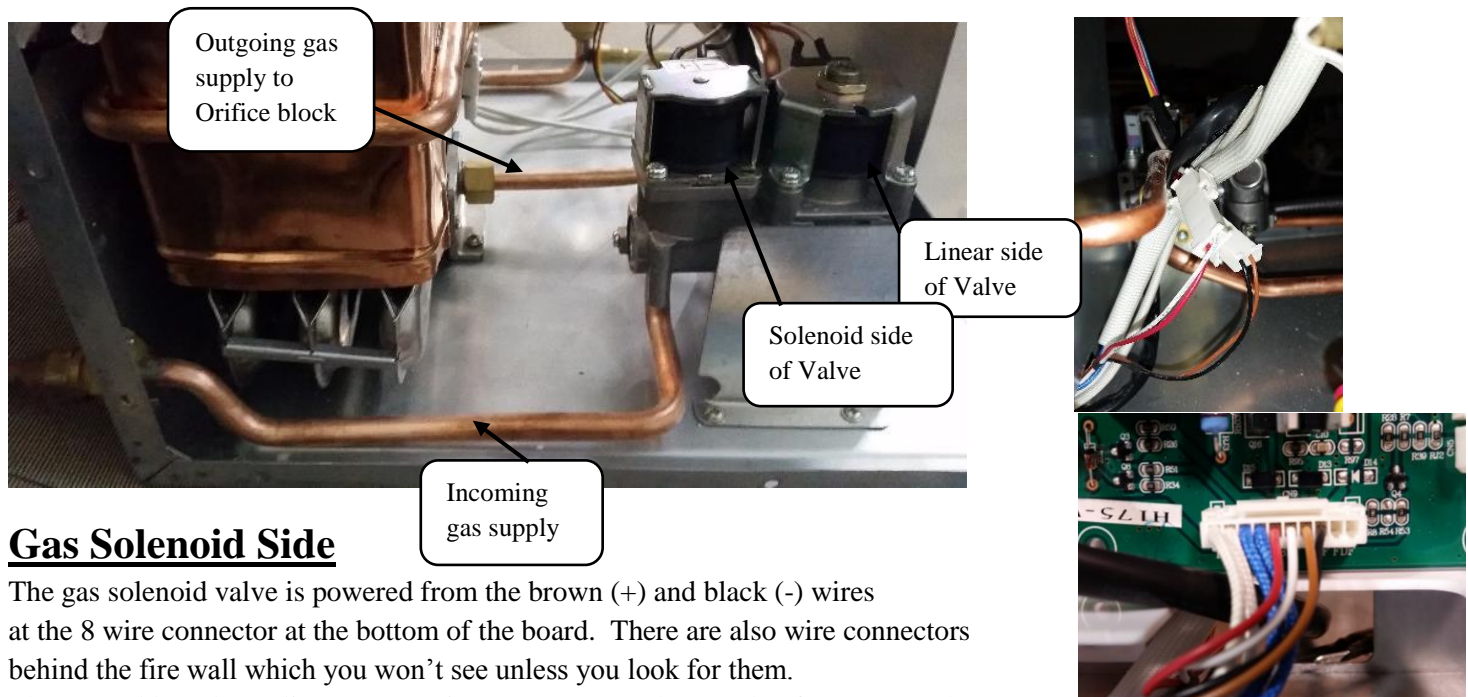

## Gas Solenoid Side

The gas solenoid valve is powered from the brown (+) and black (-) wires at the 8 wire connector at the bottom of the board. There are also wire connectors behind the fire wall which you won't see unless you look for them.

The control board supplies an approximate 50 percent duty cycle of 24VDC to the gas solenoid side of the valve. See the chart shown on page 18. Because the voltage is turning on and off many times a second the voltage can be measured with a volt meter. You should find approximately 12VDC on a volt meter. If the voltage is not around 12VDC then there is a problem with the wire connections or from the power output of the board.

If the solenoid gas valve fails to open, then no gas will be supplied to the burner and an E1 fault code will occur.



## Girard GSWH-2: E-1 Code/Gas Valve Troubleshooting and R&R

The E1 fault code tells you that the water heater tried to ignite twice but did not ignite. An E1 fault code is not always caused by a failure of the gas valve to open. Additional diagnosis needs to be performed since this fault code may be caused by a number of issues. The other causes are listed below and in the owner's manual.

### E1: Ignition failure or accidental flame off during ignition.

If the established flame signal is lost while the burner is operating, the control will respond within 0.8 seconds, the gas valve is de-energized and a new inter-purge and ignition routine will begin. If the burner does not light, the control will de-energize the gas valve and will make one more attempts to relight the burner. If the burner does not relight after the two trials the control will go into LOCKOUT and the unit will need to be turned off before it can operate again. Turn hot water faucet OFF and back ON to reset (you should try this cycle 3 times). Not lighting could occur for a number of reasons.

The most common are:

- Lack of Gas in the tank
- Faulty Igniter
- Faulty Igniter connections
- Improper distance between the Igniter and the Burner
- Accumulated dirt or obstruction between Igniter and Burner
- Low Gas Inlet pressure

### Diagnosis of an E1 fault code

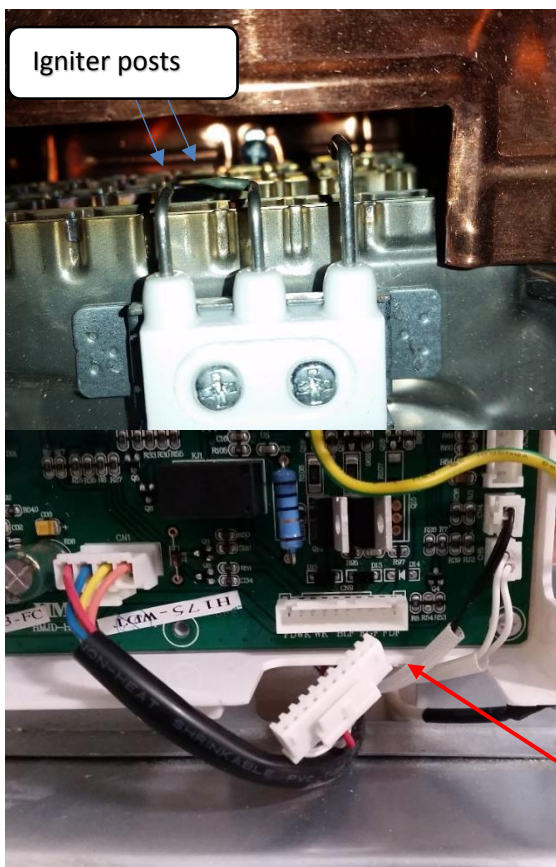

1. Confirm that gas has purged through the entire gas plumbing system by lighting the range and resetting the water heater a minimum of three times.
2. Confirm that the spark is occurring at the tips of the igniter. Visually inspect the igniter for obstructions or debris.
3. Smell for the scent of gas from the exhaust during the two trials for ignition.
4. Check the brown and black wires on the 8 pin wire connector at the bottom right side of the board to ensure integrity. Unplug the connector, gently pull on the brown and black wires. Visually inspect the connector and plug it back in.

CN9 Connector

Gas Valve Wires are the Brown and Black wires

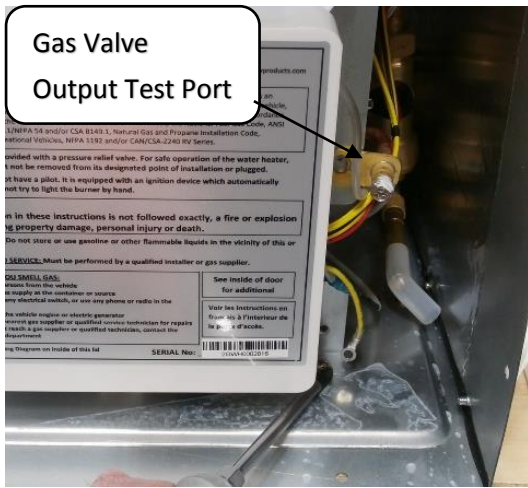

5. Check voltage between the brown and the black wires during the trial for ignition. You should have 12VDC
6. The resistance on the coil should be approximately 110 ohms.
7. The output gas pressure of the gas valve can be measured at the test port on the right side of the board. There should be 1.5" WC on low heat and 7.8" WC on high heat. If there is no pressure, then the gas valve is not opening.
8. Restrictions in the gas system can prevent gas from getting to the water heater. Just because there is gas everywhere else doesn't mean you actually have good gas flow to the water heater.

## Linear Valve Side

The board also sends voltage to the linear (modulator) side of the gas valve on the red (+) and white (-) wires at the 8 wire connector at the bottom of the board. The Voltage will vary from 11.24VDC in low and 18VDC and upward to 20VDC. As voltage increases the plunger in the valve is pushed downward allowing for more gas flow to the burner.

Even though we are able to test the voltage with a volt meter the actual voltage the control board is sending to gas valves is not standard DC volts. The actual voltage shown below is more energy efficient and this is also how the control board measures the operation of the linear valve.

GSWH-2 Valve test (Lab. Power Supply)

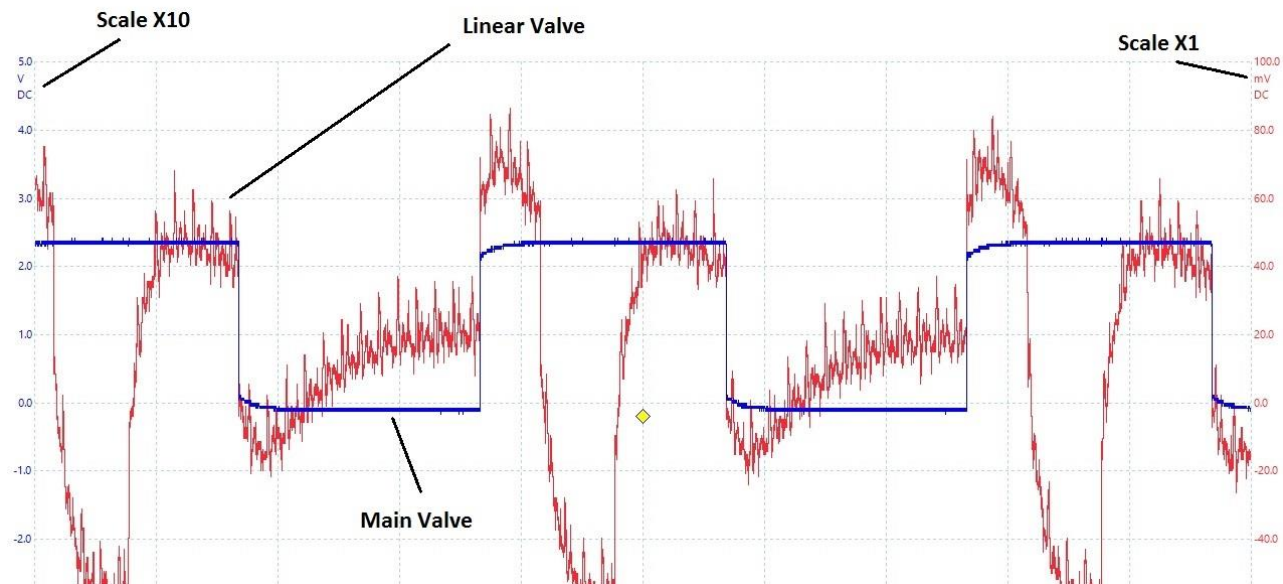

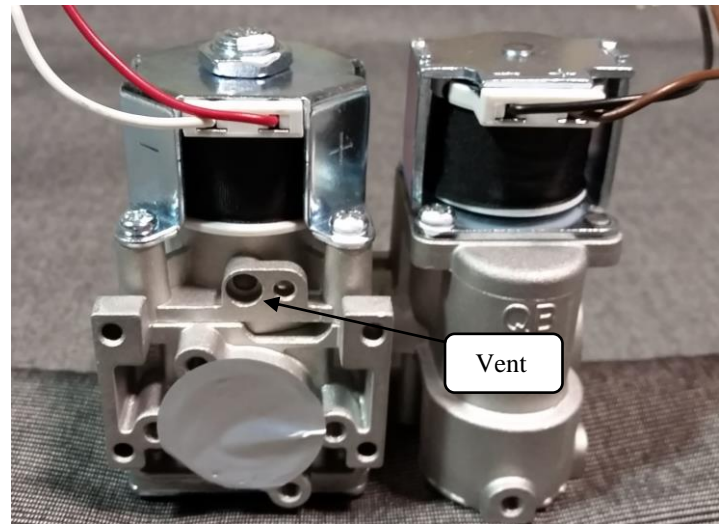

If an E7 fault code appears then the board is not sensing the linear valve. If this occurs, then you will need to check the connection of the white and red wires on the 8 wire plug as well as the connections behind the firewall. The resistance of the coil of the linear valve can be measured at the white and red wires of 8 wire connector when it is unplugged. The resistance is approximately 85 ohms.

**E7: Linear valve failure:**

The Controller Module detects an open circuit in the Linear Valve control circuit before ignition or during normal operation indicating a faulty Valve.

## **Removal and Replacement of Gas Valve**

1. Turn off the power switch or pull the fuse to turn OFF power to the water heater.
2. Remove the power switch by pressing down on the top tab and up on the bottom tab.
3. Pull the switch out and pull the wires through the opening.
4. Then remove the 15 mm nut from the fuse holder.

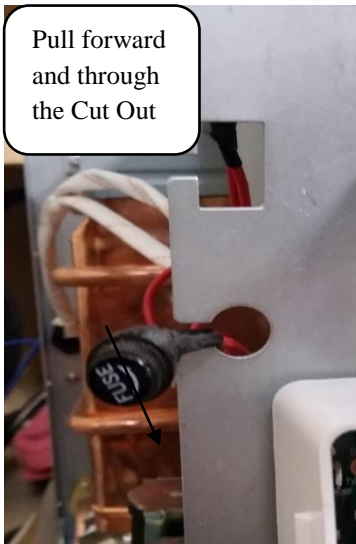
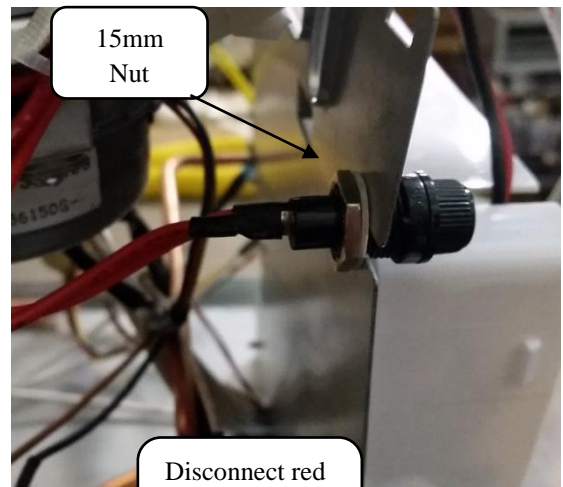

5. Pull the fuse holder out and the wires through the cut out.
6. Disconnect the input power connector and pull it through the board panel.

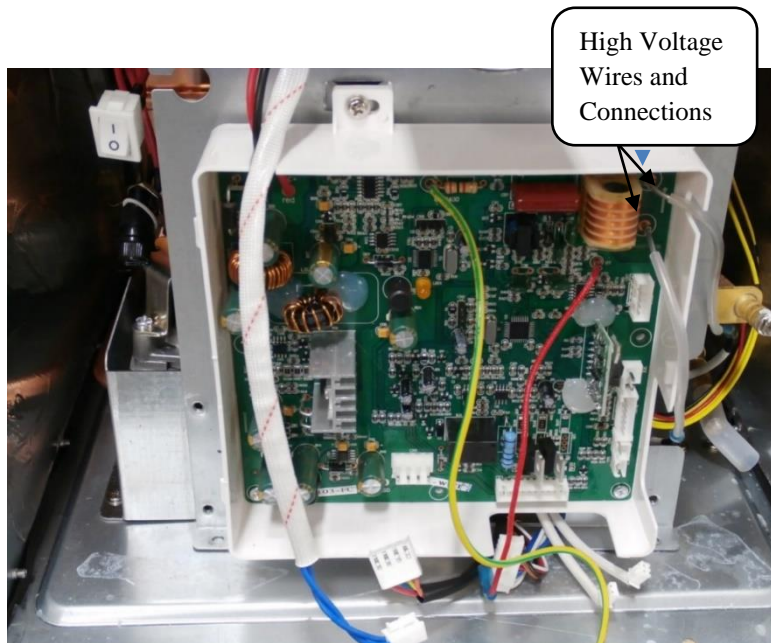
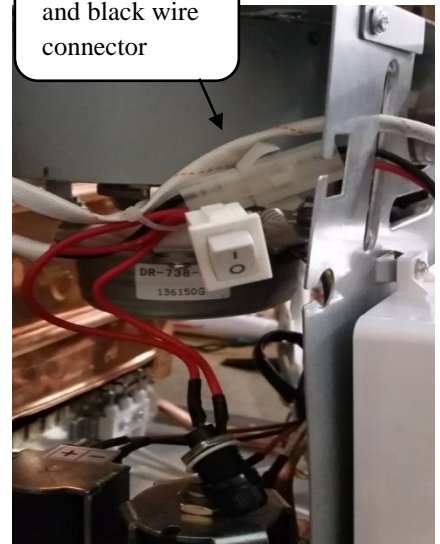

7. Remove the wire connectors from Main Control Board leaving the high tension lead wires connected. All wire connectors are unique.

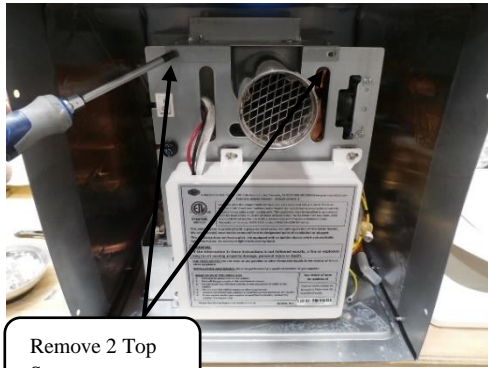

Remove 2 Top  
Screws

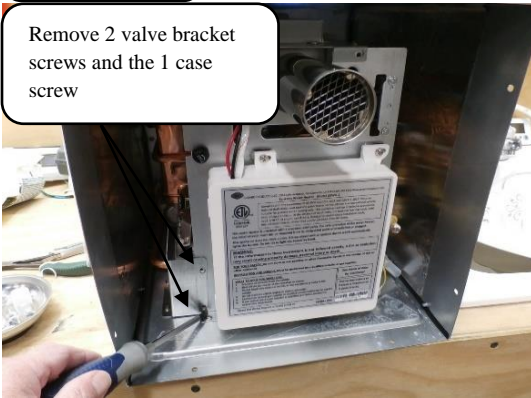

Remove 2 valve bracket  
screws and the 1 case  
screw

8. Remove the Philips screws secure the fire wall to the blower housing, gas valve bracket, ground, gas test port and bottom case.

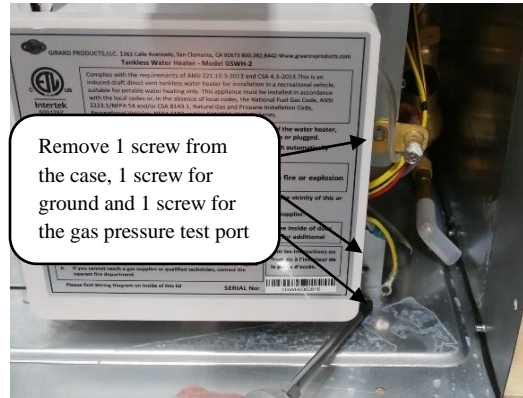

Remove 1 screw from  
the case, 1 screw for  
ground and 1 screw for  
the gas pressure test port

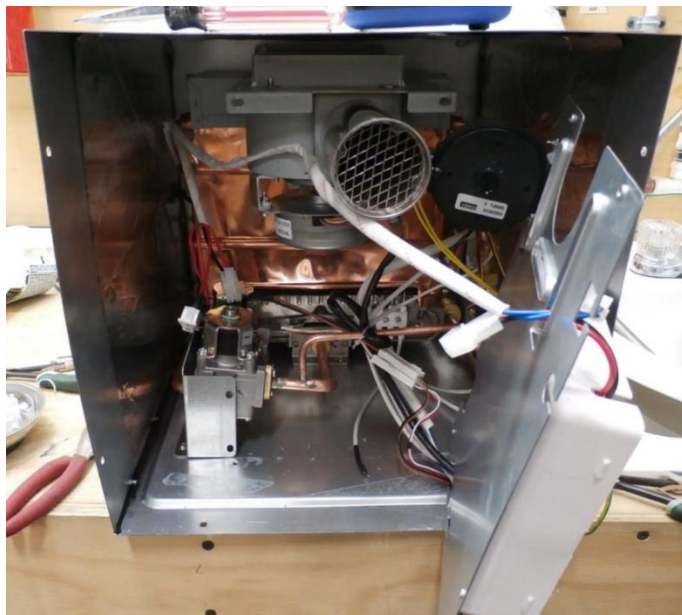

9. Lift the firewall and shift it to the right away from the gas valve bracket. Swing the board and the panel to the right giving access to the internal components.

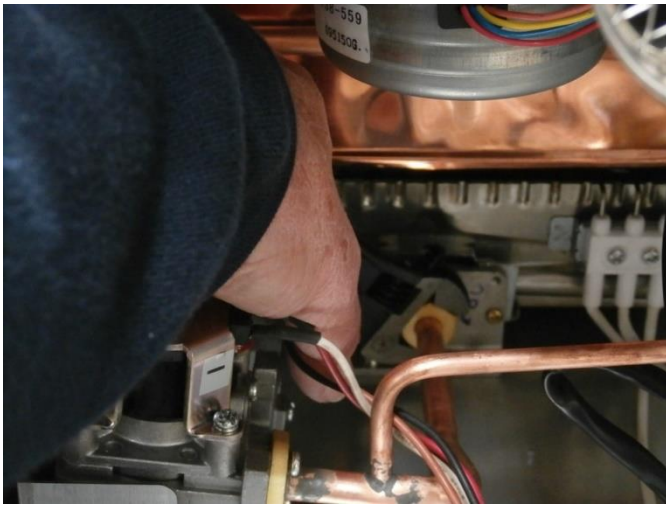

10. Remove the gas line from the orifice block using a 19 mm or 3/4 inch wrench.
11. Remove the gas line from the water heater and cover to prevent damage.

Warning: Do not over tighten gas connection when reattaching it to the orifice block

12. Remove three screws from the gas input fitting.

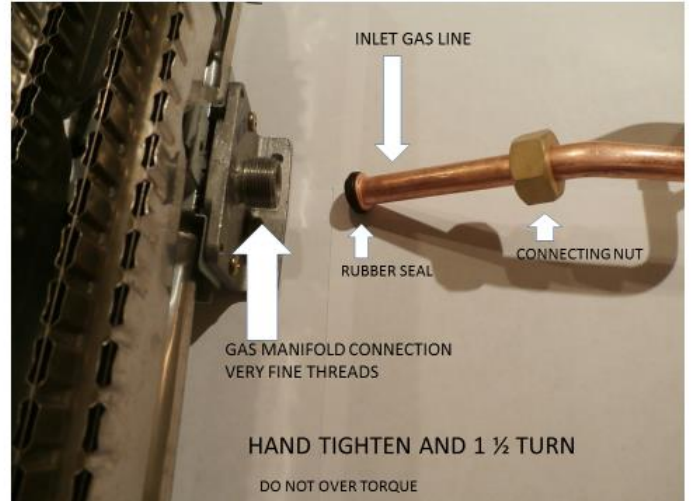
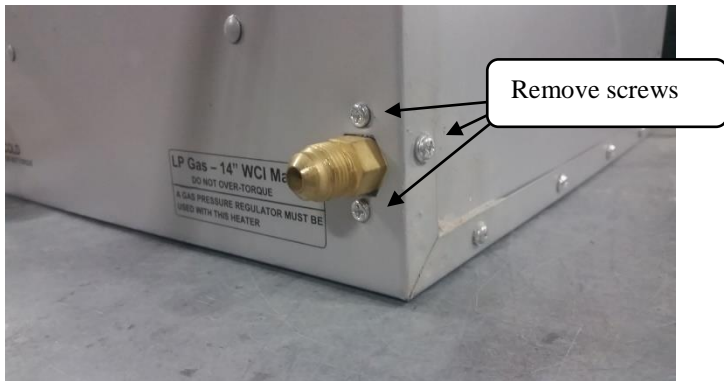

13. Remove the screws from Gas Valve bracket.
14. Pull gas valve out maneuvering the gas line past the burner.

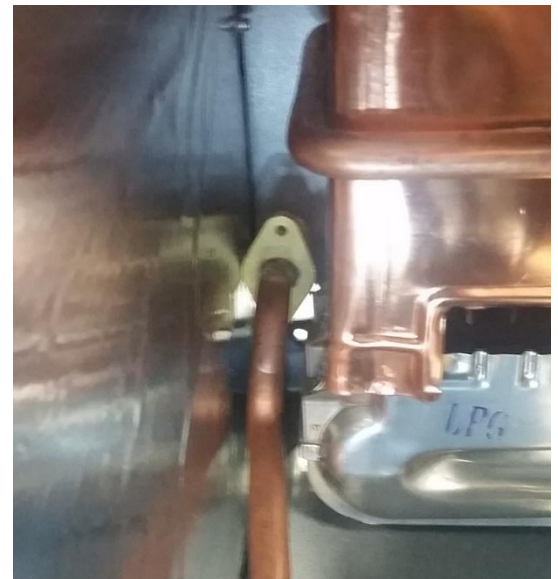

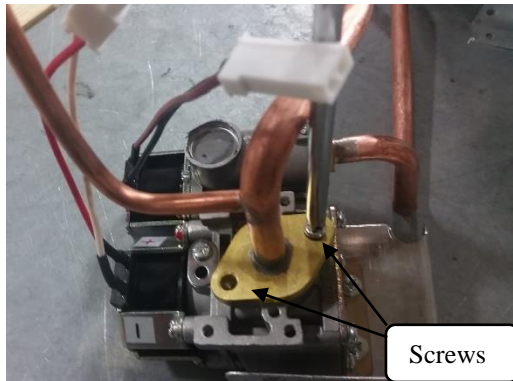
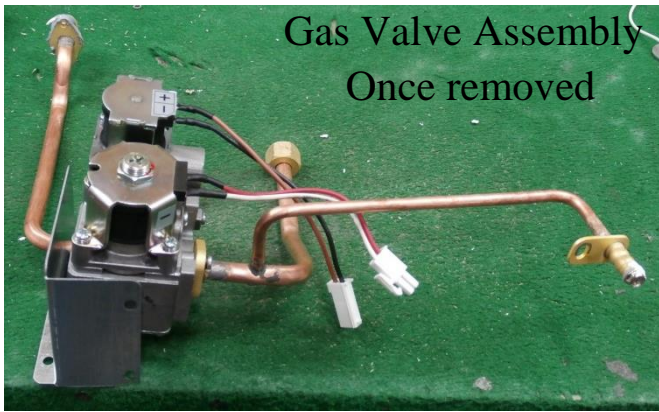

14. Remove the output gas line from the gas valve. Note the position of the O Ring. Loosen the set screws that hold the gas line place.

15. Remove the set screws that hold the input gas line in place. Remove the gas line from the valve.



16. Inspect the O ring on the input gas line. Ensure there are no cuts or tears.

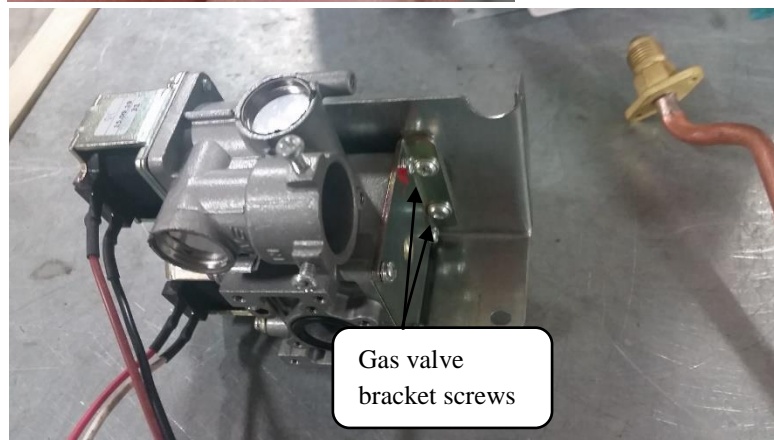
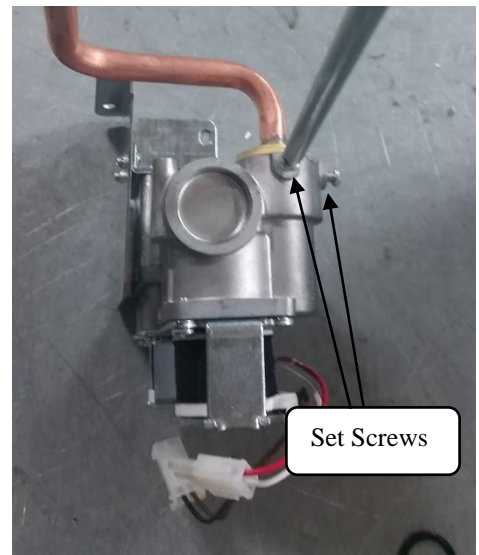

17. Remove bracket from the original gas valve and place it on the new valve.

18. Reassemble gas lines back onto the gas valve and install back into the water heater & check for leaks.

## Orifice Block:

The orifice block is located under the burner. It has 6 orifices metering gas into the burners. Three to the left and three to the right. Debris in the orifices can cause poor flame quality and can cause insufficient temperature rise.

### Removal and replacement:

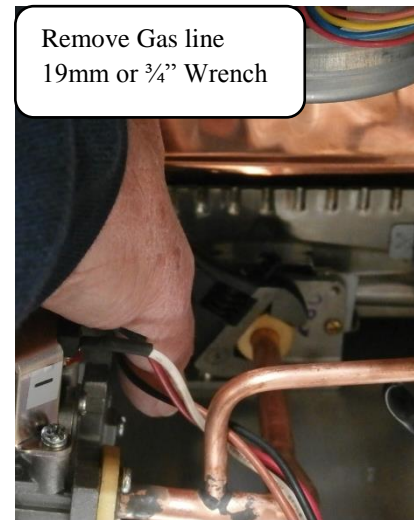
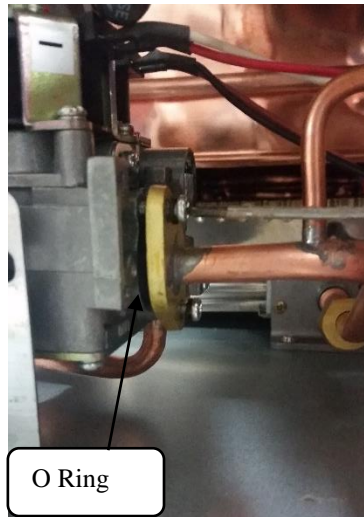
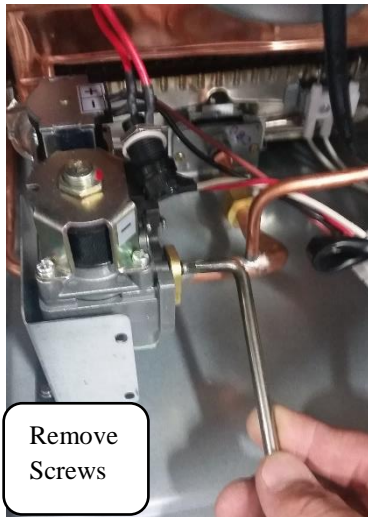

1. Remove the output gas line mounting screws. Pay close attention to the integrity and mounting of the O ring.
2. Remove the Gas line with a 19mm or 3/4" wrench. Pay close attention to the integrity and the mounting of the O Ring.
3. Pull the gas line away from the orifice block.
4. Remove two screws mounting the bracket to the case.
5. Remove two screws mounting it to the burner.
6. Pull orifice block tabs out of the notches in the base of the burner.

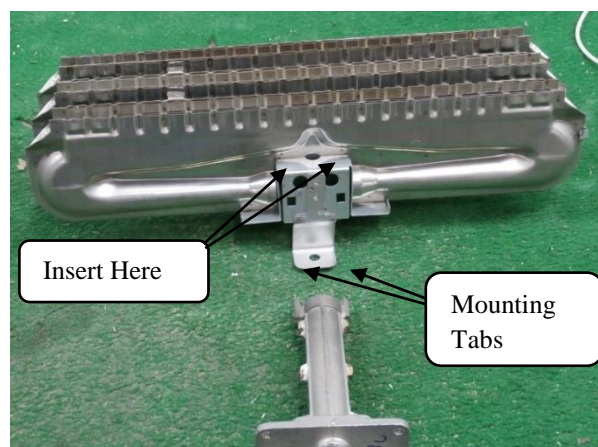

### Burner shown reversed

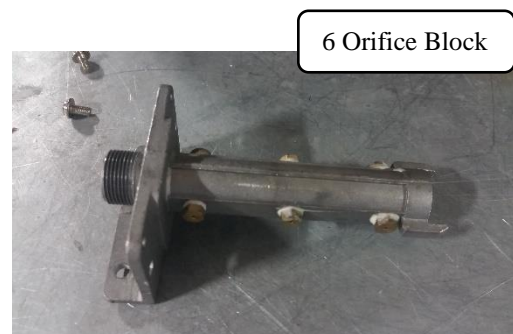



## Burner Assembly

### Removal and replacement

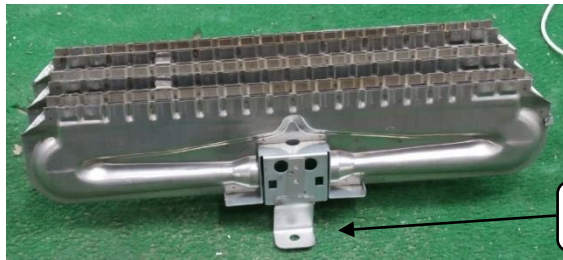

Bracket - Catch

Once the orifice block is removed the only thing holding the burner assembly in is the bracket in the catch.



Reach into the back under the burner and bend the bracket to about a 45 degree angle and pull the burner bracket out of the catch.



### Spark Probe Assembly

3 post igniter assembly

High voltage is sent to the igniter from the wires at the top right of the board. One is ground and one is high voltage. There are spade type connectors between the board and the spark probe assembly. Ensure connections are good.

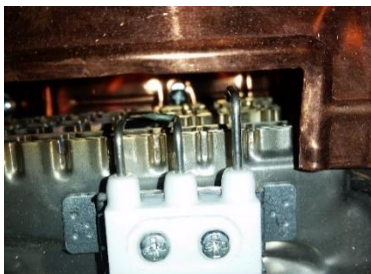

Flame Sense Wire

High Voltage output & Ground

High Voltage Wire Connections. Clear insulation covered on Newer Versions,

### If no spark occurs:

Check for cracks on the ceramic of the igniter. Check the wire connections. Unplug the high voltage connection, using insulated pliers, hold the connector approximately 1/8" from the case and look for spark.

Slow spark is probably a sign of an igniter problem.

## **Flame sense**

The flame sense probe is the right hand post of the igniter assembly which wires into the red wire on the board.

There is a 7 second trial for ignition. Once the flame is lit and on the flame sense probe it should take a second for the control board to recognize the flame. The control board turns off the spark and leaves the gas on.

If the flame is not detected then the board continues to spark the entire 7 seconds. Then the board turns off the gas and the spark and enters a purge cycle for approximately 30 seconds. Then there is another trial for ignition. If there is no ignition or the flame is not sensed then the board will go into an E1 lock out fault which will show on the UCP.

There are two fault codes for flame sense. You will see E2 when you turn off the gas supply to the water heater as it is operating or if you have just enough of a flame during ignition to warm the flame sense probe.

### **E2: Flame sensing interrupted during normal operation. Buzzer will sound.**

Possible causes are the same as indicated by Error E1 if any of these conditions occur during normal operation. A lock out will occur also in these conditions.

### **E9: Flame sensor:**

Flame is sensed before ignition. Buzzer will sound. This is displayed when a short is detected in the flame sensor.

## **System Timer:**

The board turns off the burning and shows an “En” code on the UCP after 20 minute of operation. A soft reset (turn the hot water faucet off and then back on) will reset the water heater.

### **En: System Timer:**

Water Heater ran longer than 20 min.

## **Winterization**

Freezing of the water heater and its plumbing components will result in severe damage that is not covered by warranty. For this reason, the water heater contains a winter use device that will keep the water heater from freezing when using the RV is freezing conditions. See the information about the Winter Use Device for proper use.

At the start of the winter season or before traveling to a location where freezing conditions are likely the unit must be winterized. The very small amount of water present in the heat exchanger does not require a bypass. In fact, it is not recommended.





Freezing water inside of the heat exchanger (just like a tank water heater) will expand and cause a bulging crack on one of the copper tubes of the heat exchanger.

Winterization can be accomplished using on the two common methods of winterization used for RV systems. But we highly recommend RV Antifreeze in the water heater heat exchanger. I have had many people think they have gotten all the water out with compressed air whose water heater froze up but no one who used anti-freeze has ever had freeze damage.

- **Compressed Air Method:**  
Drain all of the water from the system opening one tap at a time and using compressed air to purge all remaining water.
- **RV Anti-Freeze Method:**  
Follow the recommendations of the Recreation Vehicle manufacturer and fill the system with a nontoxic anti-freeze. Make sure that the anti-freeze flows from each tap to complete the process.

## Winter Use Device



This water heater is equipped with an anti-freeze or winter use system. The purpose of this system is to keep the water heater from freezing when the RV is used in freezing conditions.

There is a bi-metallic thermostat located on the hot water line. This WUD thermostat is designed to turn on at 35 degrees Fahrenheit and turn off at 48 degrees Fahrenheit. When the WUD thermostat turns on the water heater will begin to operate and heat. The board will keep the fire on until the thermostat turns off at 48 degrees. At this point the flame should turn off immediately and the fan will turn off 30 seconds later. When the system operates with the winter use device an “Fd” code will show on the UCP.

**Fd: Winter Use Device thermostat has engaged turning on the water heater**

## FAQ's and Troubleshooting

The new GSWH-2 water heater differs from its predecessors in that it allows the customer to operate the product just as they would a regular tank water heater. By this we mean that they simply turn on the hot side and add cold water to their desired temperature. For this reason, we do not spend a great deal of time explaining adjustments and exceptions.

The tankless water heater is very efficient in that you are not always reheating water to maintain a certain temperature. When the hot water faucet is turned on, the water heater comes on and immediately begins making hot water at the SET temperature. We recommend 115 degrees, since this is the most efficient temperature in both propane savings and usability. Of course, the temperature setting can be adjusted from 95 to 124 degrees.

One of the advantages of this product is that the UCP will show the customer what it is doing during operation. An added feature is that most faults or defects will be displayed on the UCP's display screen, thus eliminating the time spent to determine what might be wrong when it is not operating properly.

Listed below are some of the most common concerns:

### **Hot water takes too long to get to the shower or another faucet.**

- The water heater begins making hot water as soon as the hot water faucet is turned on. The time it takes to get to the faucet is determined by the length of piping from the water heater to the faucet. This is determined by the plumbing configuration of the RV. A tank water heater will do the same thing. If a person is primarily a DRY camper, there are now devices that can be installed in their RV that will eliminate this problem.

### **Water heater does not start up when faucet is turned on (no fault code or water flow icon on display).**

- Be sure on/off switch is turned on, outside.
- Be sure UCP switch is turned on.
- Outside, remove cover on control board. Look for GREEN LED. If the green light is on, power is coming into water heater. If it is not on, check fuse and wiring. Check for separate on/off switch in RV.
- See if there is a RED LED illuminated on the board. This indicates that the incoming voltage is too low.
- Test water flow. Must have at least .8 GPM. Does flow seem low out of faucet? Open different faucets. Take strainer off one faucet.
- Confirm that water lines are connected properly. Hot to hot, cold to cold.
- Does customer use a flow restrictor on the incoming water line? If so. Remove.
- Does customer use a water filter? Is filter clean?
- Using a gallon container, check to see how much flow is coming out of the faucet. If the water flow is less than 1 GPM than have customer fill fresh water tank and run off the pump.
- If more than 1GPM, replace FLOW SENSOR.

### **Water heater come on and then locks out with an E-1 code.**

- Confirm that gas tank is turned on and that they have propane in the tanks.
- If this is the first start up, or a refilled tank, consider that the customer needs to try multiple times for startup. Turn the burners on the range to get the gas moving through the system.
- Tap on the gas valve. If it starts, then replace the gas valve.

- Smell for gas coming out of the exhaust.
- If the weather is cold, do they have enough propane in the tank?
- Is the regulator on the tank working?
- Replace gas valve.

**Water heater comes on and immediately gives an E-5 code (motor failure).**

- Confirm that motor is not jammed by physically turning the blower under blower housing.
- Check the wire CN1 wire connection at the control board.
- Replace motor or water heater.

**Water heater blower motor does not come. (No fault code - water flow icon is on).**

- Confirm that motor is not jammed by physically turning the blower under blower housing.
- Check the wire CN1 wire connection at the control board.
- Replace the control board.

**Water heater comes on and then give E-8 code (air pressure switch).**

- Confirm that nothing is blocking the exhaust vent.
- Confirm that the plastic tube is connected to the blower and pressure switch.
- Check the lock nut at the bottom of the blower, where the plastic tube attaches. If it is loose, tighten.
- Look through the exhaust and confirm that the petit tube is facing away from the blower wheel. (works with suction)
- Confirm wires are attached properly.
- Replace pressure switch.

**Water heater comes on and then goes to an E-3 code. (ECO tripped).**

- Confirm that the customer has enough water pressure.
- Have customer set thermostat to 115 degrees or lower.
- Jump ECO to confirm that the ECO is not defective. If the W/H works properly then replace ECO.
- If customer is in very hot conditions, he may have to replace the current ECO with a higher degree one.

**Water heater burner comes on and then shuts off/ on and off**

- Confirm gas line connection is not kinked.
- Confirm tank regulator is working properly.
- Confirm that electrode wires are properly connected.
- Confirm that electrodes are installed correctly, and not loose.
- Listen for SLOW sparking at the electrodes, if so, replace electrodes.
- Replace board.

**Customer cannot control the temperature from set point, get too hot and then maybe too cold.**

- Purge water lines.
- Water pressure too low. Some campgrounds have the water pressure very low. Try putting water in the fresh water tank and running off the pump.
- Set temperature lower.
- Possible partial by-pass opened.
- Possible, outside shower faucets turned on and just the shower button closed. Same for inside shower.
- Possible, outlet temperature probe, defective. Have not confirmed this.
- Replace water heater.

**Malfunction 1: Unit does not attempt to light when water is turned on**

**Error codes: E0, E3, E4, E5, E7, E8, E9**

**Procedure:**

If any of the above Error codes are displayed proceed as follows:

1. E0 - Verify connections to the Probe. Verify with a Voltmeter that the resistance of the outlet probe is not an open circuit or a short. If it is install a new Probe.
2. E3 - Verify with a Voltmeter that the resistance of the ECO is not an open circuit. Let water flow through the unit to cool off. If needed install new ECO
3. E4 - Verify with a Voltmeter that the resistance of the inlet probe is not an open circuit or a short. If it is install a new Probe.
4. E5 - Verify Motor power connection.
5. E7 - Inspect Linear Valve.
6. E8 - Inspect Air Pressure Switch.
7. E9 – Verify that there is a short in the flame sensor (Sensor touching burner or wires shorted)

**Malfunction 2: Unit attempts to light but does not ignite the gas**

**Error codes: E1**

**Procedure:**

Inspect Major Components (See below)

Verify that none of the following conditions are present:

1. Lack of Gas in the tank
2. Faulty Igniter (no spark)
3. Faulty Igniter connections
4. Improper distance between the Igniter and the Burner
5. Accumulated dirt or obstruction between Igniter and Burner
6. Low Gas Inlet pressure

Correct any improper condition and install a new Igniter if needed.

**Malfunction 3: Unit ignites the gas but shuts off soon after**

**Error codes: E2**

**Procedure:**

1. Notice if buzzer sounds to indicate the failure of the flame sensor.
2. Follow same procedures outlined for Malfunction 2 above looking specifically at the Igniter electrodes.

**Malfunction 4: Unit shuts off while running**

**Error codes: E1**

1. Make sure that the ECO is not open. If it is run cold water through the unit too cool off the ECO.
2. Follow same procedures outlined for Malfunction 2 above

**Malfunction 5: Water output temperature is less than indicated on the User Control Panel (UCP)**

1. Verify the manifold pressure of the gas at the test port using the Manometer.
2. Make sure that the voltage applied to the Mather board is >11V
3. Verify accuracy of the outlet temperature probe using a thermocouple or thermometer.

**Malfunction 6: Unit is too noisy**

Inspect motor and blower assembly to determine a possible cause.

## Error Codes on User Control Panel

### **E0: Water Outlet Temperature Probe failure.**

An open circuit or short circuit condition is detected: This could be due to an internal failure in the Temperature Probe or to a faulty connection (Wires)

### **E1: Ignition failure or accidental flame off during ignition.**

If the established flame signal is lost while the burner is operating, the control will respond within 0.8 seconds, the gas valve is de-energized and a new inter-purge and ignition routine will begin. If the burner does not light, the control will de-energize the gas valve and will make two attempts to relight the burner. If the burner does not relight after the three trials the control will go into LOCKOUT and the unit will need to be turned off before it can operate again. This could occur for a number of reasons. The most common are:

- Lack of Gas in the tank
- Faulty Igniter
- Faulty Igniter connections
- Improper distance between the Igniter and the Burner
- Accumulated dirt or obstruction between Igniter and Burner
- Low Gas Inlet pressure

### **E2: Flame sensing interrupted during normal operation. Buzzer will sound.**

Possible causes are the same as indicated by Error E1 if any of these conditions occur during normal operation. A lock out will occur also in these conditions.

### **E3: ECO open before ignition or during normal operation.**

This occurs if the ECO thermostat opens. Under normal circumstances this is due to the Temperature of the water at the Outlet exceeds 79°C. The cause must be identified and removed before restarting the unit.

### **E4: Water Inlet Temperature Probe failure.**

An open circuit or short circuit condition is detected: This could be due to an internal failure in the Temperature Probe or to a faulty connection (Wires)

### **E5: Blower motor failure.**

No motor signal was detected before ignition or during normal operation. This could be also caused by a wiring fault in the motor connections.

### **E6: Over Temperature.**

Outlet Water Temperature has exceeded 60°C for 3 sec.

### **E7: Linear valve failure:**

The Controller Module detects an open circuit in the Linear Valve control circuit before ignition or during normal operation indicating a faulty Valve.

### **E8: Air pressure switch:**

Air pressure switch not detected for 7 sec. before ignition or is cut-off for 2 sec. during normal operation. This failure may be caused by a faulty motor or a blockage in the air supply or in the exhaust system.

### **E9: Flame sensor:**

Flame is sensed before ignition. Buzzer will sound. This is displayed when a short is detected in the flame sensor.

### **End: System Timer:**

Water Heater ran longer than 20 min.

# Exploded View

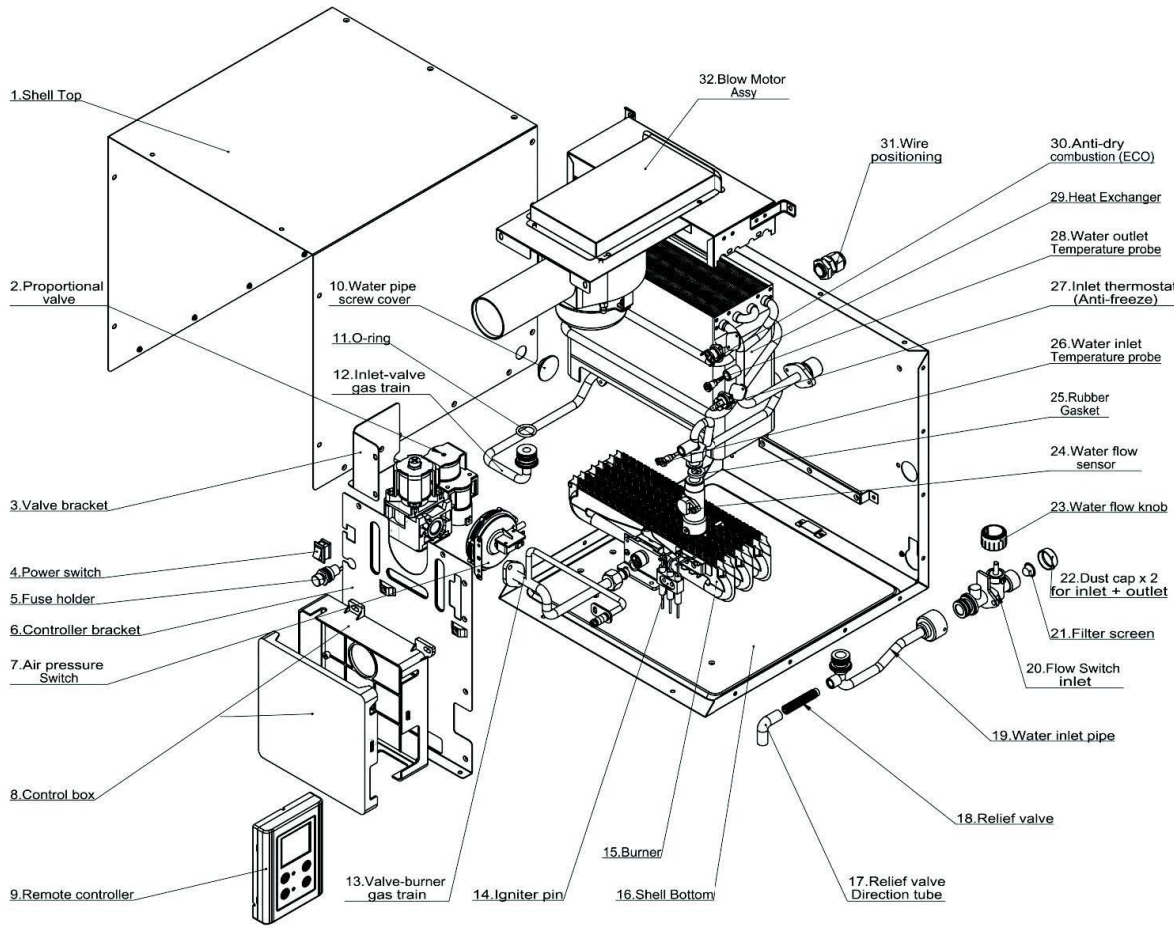



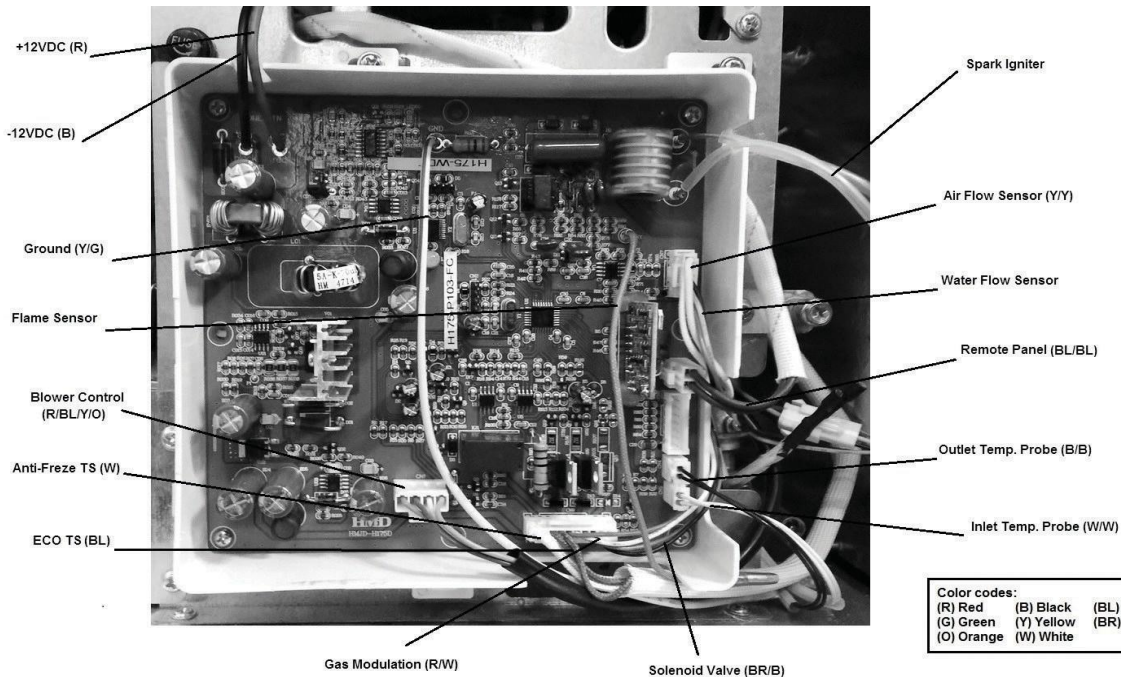













Item	Name	Qty
1	Shell Top	1
2	Proportional valve (valve)	1
3	Valve bracket	1
4	Power switch	1
5	Fuse holder	1
6	Controller bracket	1
7	Air pressure Switch	1
8	Control box	1
9	Remote controller	1
10	Water pipe screw cover	1
11	O-ring	1
12	Inlet-valve gas train	1
13	Valve-burner gas train	1
14	Igniter pin	1
15	Burner	1
16	Shell Bottom	1
17	Pressure Relief valve Direction tube	1
18	Pressure relief valve	1
19	Water pipe assy	1
20	Flow Switch inlet	1
21	Filter screen	1
22	Dust cap for inlet + outlet	2
23	Flow Switch inlet - Knob	1
24	Water flow sensor	1
25	Rubber gasket	2
26	Temperature probe for water inlet	1
27	Inlet thermostat (Anti-freeze)	1
28	Temperature probe for water outlet	1
29	Heat Exchanger	1
30	Anti-dry combustion (ECO) T-Switch	1
31	Wire positioning	1
32	Blow Motor Assy	1





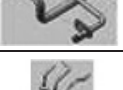

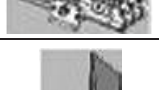









Color codes:  
 (R) Red (B) Black (BL) Blue  
 (G) Green (Y) Yellow (BR) Brown  
 (O) Orange (W) White



## Replacement Parts: Components

#	Description	Photo	Qty.
1	Shell Top		1
2	Proportional Valve (Gas Valve)		1
3	Valve Bracket		1
4	Power switch & Fuse holder Assy		1
5	External Fuse10A		1
6	Controller Bracket		1
7	Air Pressure Switch		1
8	Control Box (Microprocessor)		1
9	User Control Panel (UCP) Remote Cont.		1
10	Water Pipe Screw Cover		1
11	O-Ring		1
12	Inlet-Valve Gas Train		1
13	Valve-Burner Gas Train		1
14	Igniter		1
15	Burner		1
16	Shell Bottom		1

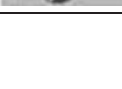
#	Description	Photo	Qty
17	Pressure Relief Valve Direction Tube		1
18	Pressure Relief Valve		1
19	Water Pipe Assembly		1
20	Flow Switch Inlet		1
21	Filter Screen Inlet		1
22	Dust Cap: Inlet/Outlet		1
23	Flow Switch Inlet Knob		1
24	Water Flow Sensor		1
25	Rubber Gasket		1
26	Temperature Probe for Water Inlet		1
27	Inlet Thermostat (Antifreeze)		1
28	Temperature Probe for Water Outlet		1
29	Heater Exchanger		1
30	(ECO) T-Switch		1
31	Strain Relief		1
32	Blow Motor Assembly		1

# Functional Diagram

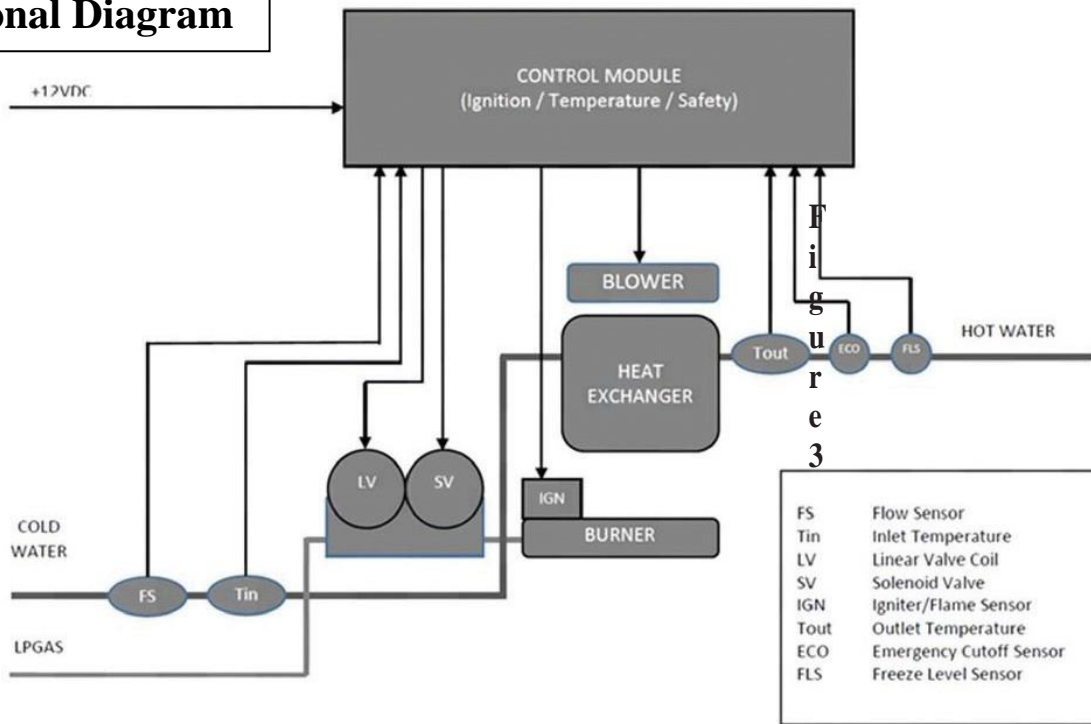

# Wire Diagram

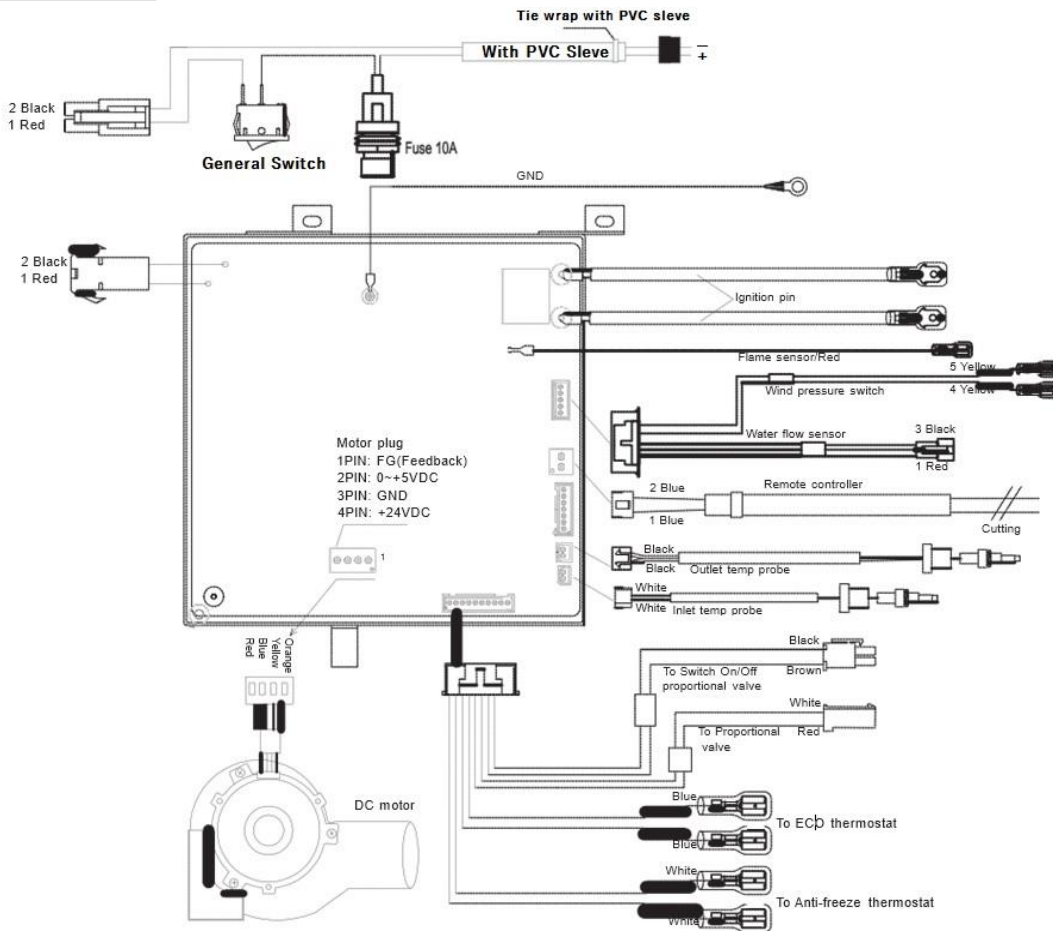

# GIRARD PRODUCTS LLC

## GSWH-2 WARRANTY FLAT RATE LABOR HOUR GUIDELINES

TIME ALLOWANCE INCLUDES DIAGNOSTIC TIME (In hours calculated at 1/10th hour - 6 minutes)

<u>LABOR FUNCTION</u>	<u>APPROVED LABOR HRS.</u>
Complete Water Heater*	1.2 hours
Door Frame (flange)	.50 hour
Gas valve (proportional)*	1.0 hour
Control Board (Main Board)*	.70 hour
User Control Panel	.50 hour
Pressure Relief Valve Assy.	.30 hour
Water Flow Meter	.60 hour
Pressure Switch	.50 hour
ECO	.50 hour
Power switch and fuse holder Assy.	.50 hour
WUD Thermostat	.50 hour
Temperature Probe Outlet (Hot Water)	.60 hour
Temperature Probe Inlet (Cold Water)	.60 hour
Burner Orifice Block	.80 hour
Burner Assembly	1.2 hours

**\*For any component that does not appear on the above list, contact Girard Products LLC for authorization and instructions. Labor will not be paid until part is returned.**

To process a warranty claim the Service Center must be an authorized Girard Products, LLC Service Center.

Authorized Service Centers must obtain prior approval for work that exceeds the flat rate time allowances.

Operational failure caused by improper installation or the use of non GSWH-2 components will result in the warranty claim being denied.

All warranty parts in the first year of warranty will be ship FedEx ground. Contact Girard Products Customer Service with questions or concerns about labor hour's guidelines or labor functions (949) 259-4024.

**GIRARD PRODUCTS, L L C**  
1361 CALLE AVANZADO, SAN CLEMENTE, CA 92673  
949-259-4024  
www.greenrvproducts.com

[Type here]

[Type here]